

SCIA
ENGINEER



TEKLA STRUCTURES
SCIA ENGINEER LINK
HELP



 **AUTODESK.**
Authorised Developer

Microsoft Partner
Gold Application Development

Contents

1	Introduction	1
2	Creating a Tekla Structures Model.....	2
2.1	Member End fixities	5
2.2	Support fixities	6
2.3	Position of analytical member	7
3	Bi-directional Link – Tekla Structures and SCIA Engineer	10
3.1.1	National code	11
3.1.2	Mode of transfer	11
3.1.2.1	Export items	11
3.1.3	Create/Update	12
3.1.4	Export / Import	12
3.1.4.1	Materials	13
3.1.4.2	Cross-section	14
3.1.4.3	Section parameters	15
3.1.5	Material mapping.....	15
3.1.5.1	Section mapping.....	17
3.1.5.2	Parameter mapping	18
3.1.5.3	Export/Import options	21
3.1.5.4	Log files	22
4	Release Notes.....	24
5	Contact Address:.....	27

1 Introduction

CADS Tekla Structures SCIA Engineer link is an application that transfers the structural model data from Tekla Structures to SCIA Engineer and vice-versa, as part of the Building Information Modelling (BIM) process. Structures modelled in Tekla Structures can be exported to SCIA Engineer for analysis and design. As a roundtrip solution, the model can then be integrated back into Tekla Structure to update the model.

This guide aims to help you understand the basics of the bi-directional Tekla Structures to SCIA Engineer link. Reading this guide will provide you with the knowledge needed to understand the link in detail.

2 Creating a Tekla Structures Model

This section explains how the analytical model can be created in Tekla Structures and exported into SCIA Engineer. The CADS Tekla Structures SCIA Engineer link works with the analytical model rather than the structural (physical) model. After the structural model is created in Tekla Structures an analytical model, also known as the mathematical model or FEM model, can be generated as shown in the example below. CADS Tekla Structures SCIA Engineer Link transfers this analytical model from Tekla Structures to SCIA Engineer.

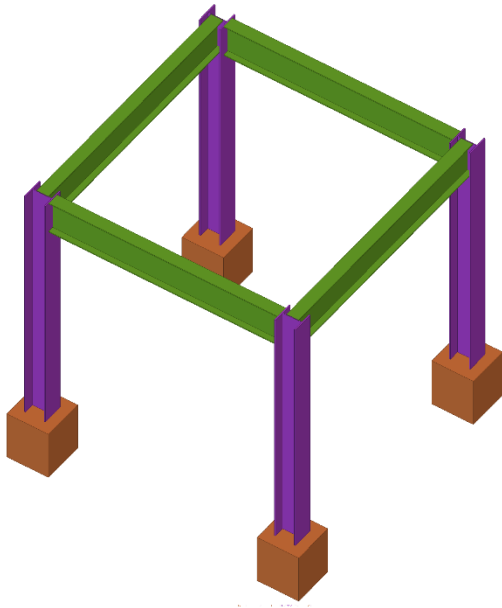

Physical model in Tekla Structures

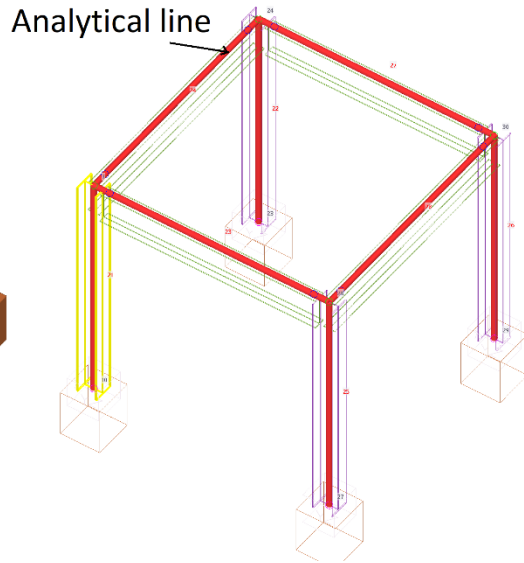

Analytical Model in Tekla Structures

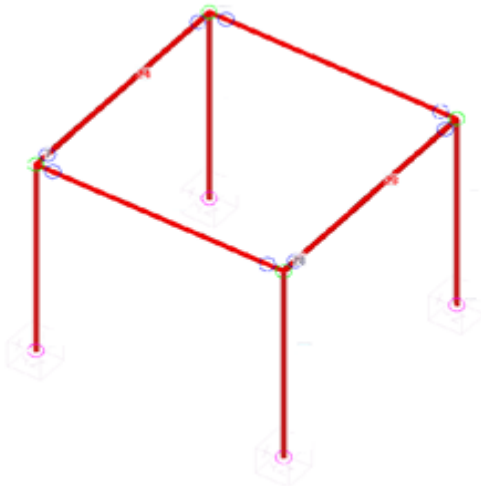

Tekla Structures – Analytical model view

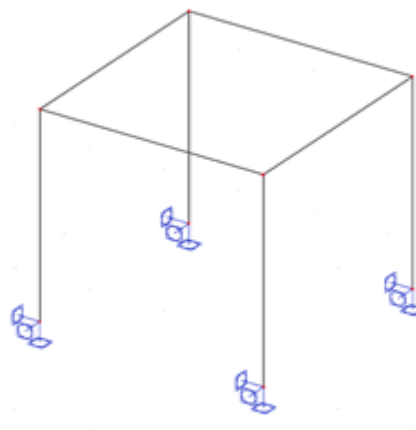

Exported Model in SCIA Engineer

The analytical model can be created from the 'A&D models' button on the ribbon under the Analysis & Design tab.

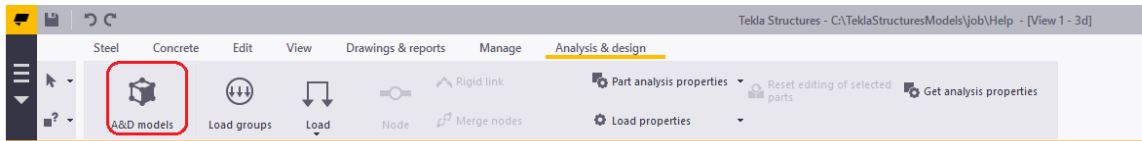

Selecting "A&D models" will display the following dialog

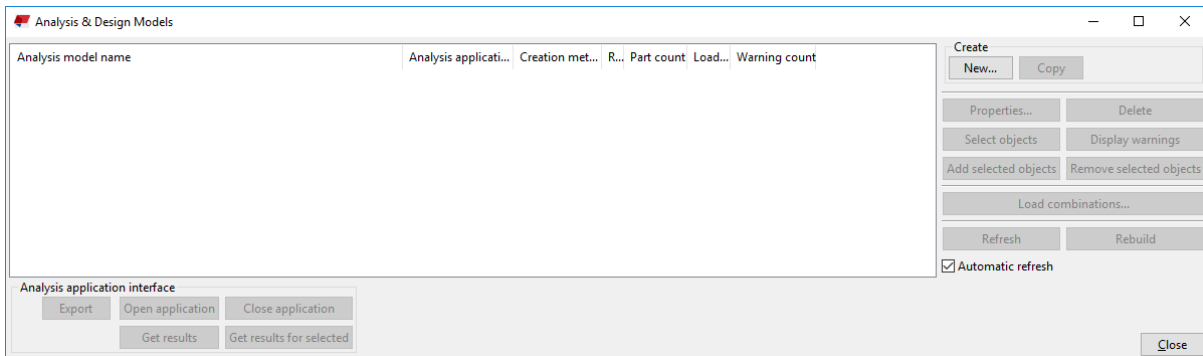

Select **New** to create a new analytical model, which opens the following dialog

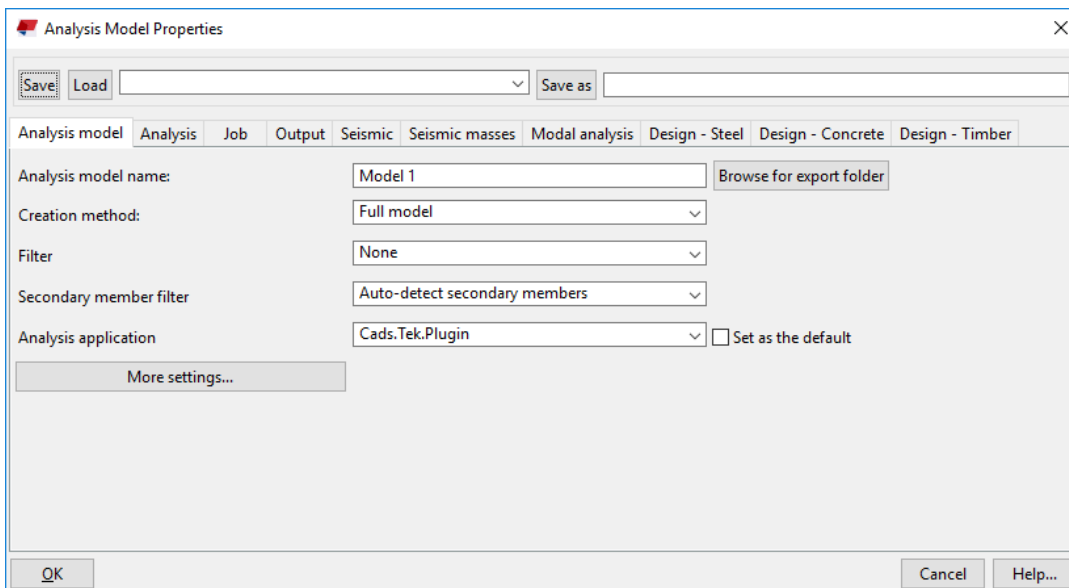

Using the Creation method option, you can choose whether the full or only a selection of members needed to be added in the Analytical model.

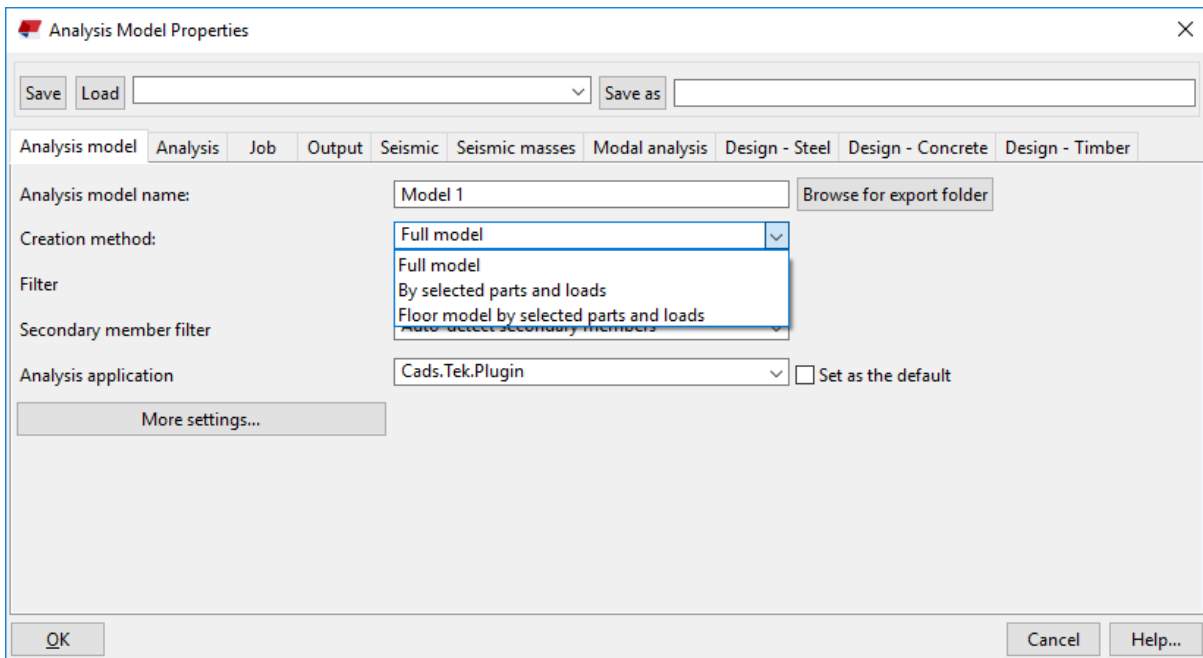

Clicking **OK** creates a new analytical model. Multiple analytical models can be created. The analytical properties of each parts can be viewed by selecting the part and clicking **Get analysis properties** option, which is under Analysis and Design Tab.

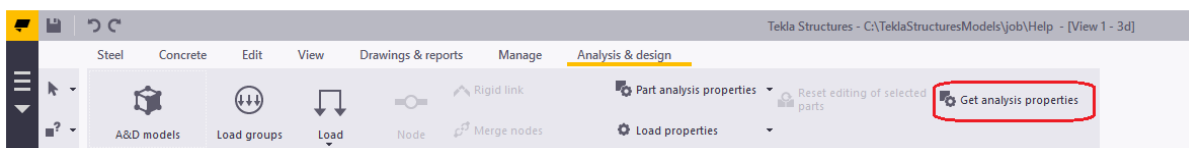

Selecting “Get analysis properties” for a 1D member will display the following dialog

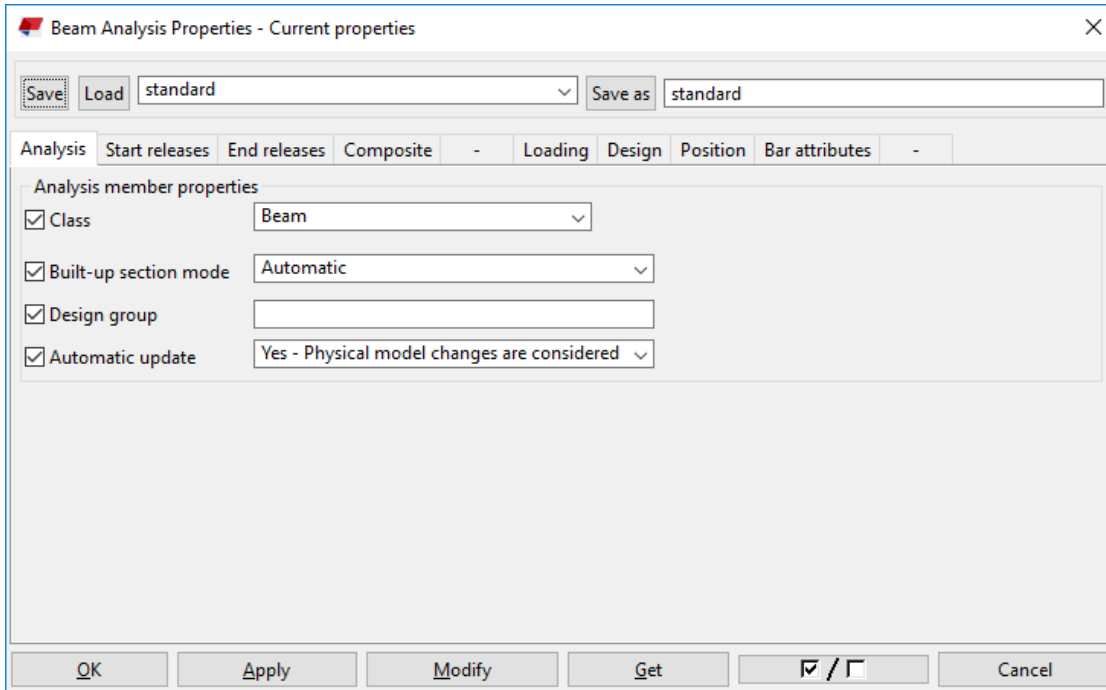

This dialog is used to change the Start release, End releases and position of analytical line of the 1D members

2.1 Member End fixities

Selecting the Start release tabs displays the below options where you can edit the fixities for the selected end of a member.

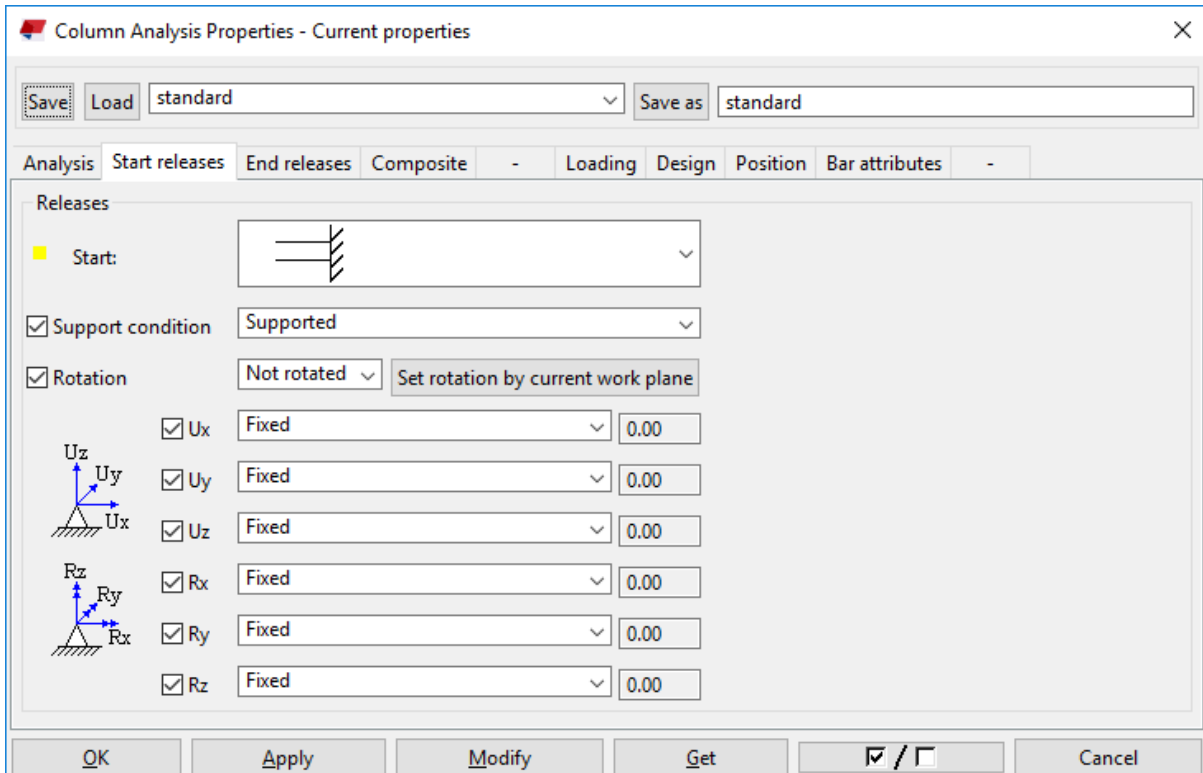

The Support condition option allows you to choose whether that particular end should be joined to another member or it should have a support.

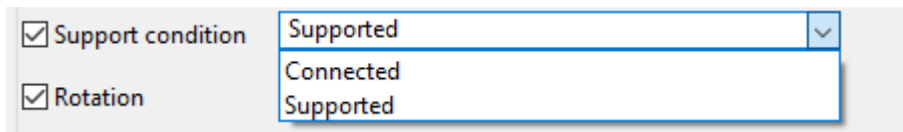

If "Supported" is chosen, supports will automatically be created at the ends where fixities have been defined.

2.2 Support fixities

The fixities of any support can be modified by changing the analytical properties of that particular node. By default, the supports option will be set to "Get supports from parts". If you want to change the support condition of that node "User defined node supports option" should be selected and the fixities are changed. This takes precedence when exporting to SCIA Engineer.

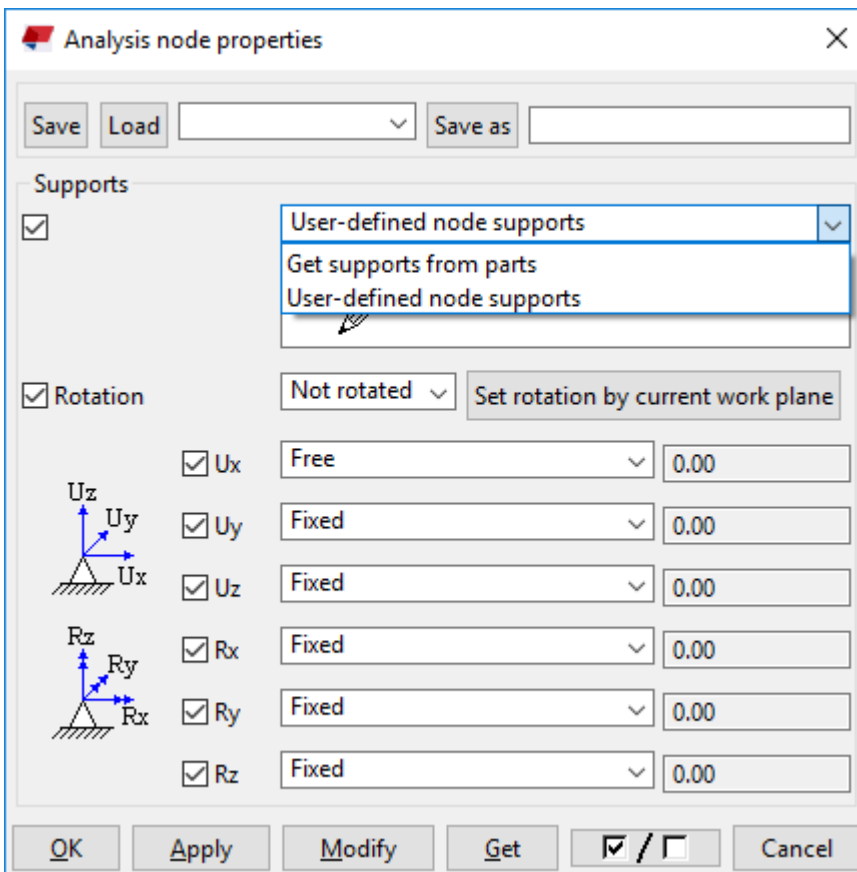

The same behaviour applies to the End release option.

2.3 Position of analytical member

The Position tab is used to define the location of the analytical line for a 1D member.

The screenshot shows the 'Column Analysis Properties - Current properties' dialog box with the 'Position' tab selected. The dialog has a title bar with a close button (X) and a 'Save' button. Below the title bar, there are 'Load' and 'Save as' buttons, both with a dropdown menu showing 'standard'. The main area contains several settings:

- Axis: Neutral axis (dropdown)
- Keep axis position: Yes (dropdown)
- Connectivity: Automatic (dropdown)
- Axis modifier X: None (dropdown), X: 0.00 (text box)
- Axis modifier Y: None (dropdown), Y: 0.00 (text box)
- Axis modifier Z: None (dropdown), Z: 0.00 (text box)
- Offset: X: 0.00 (text box), Y: 0.00 (text box), Z: 0.00 (text box)
- Longitudinal offset mode: Offsets are not considered (dropdown)

At the bottom, there are buttons for 'OK', 'Apply', 'Modify', 'Get', a checkbox with a square icon, and 'Cancel'.

The analytical line for a particular analytical model can be also be overwritten by changing the Member axis location option available in the analytical model properties.

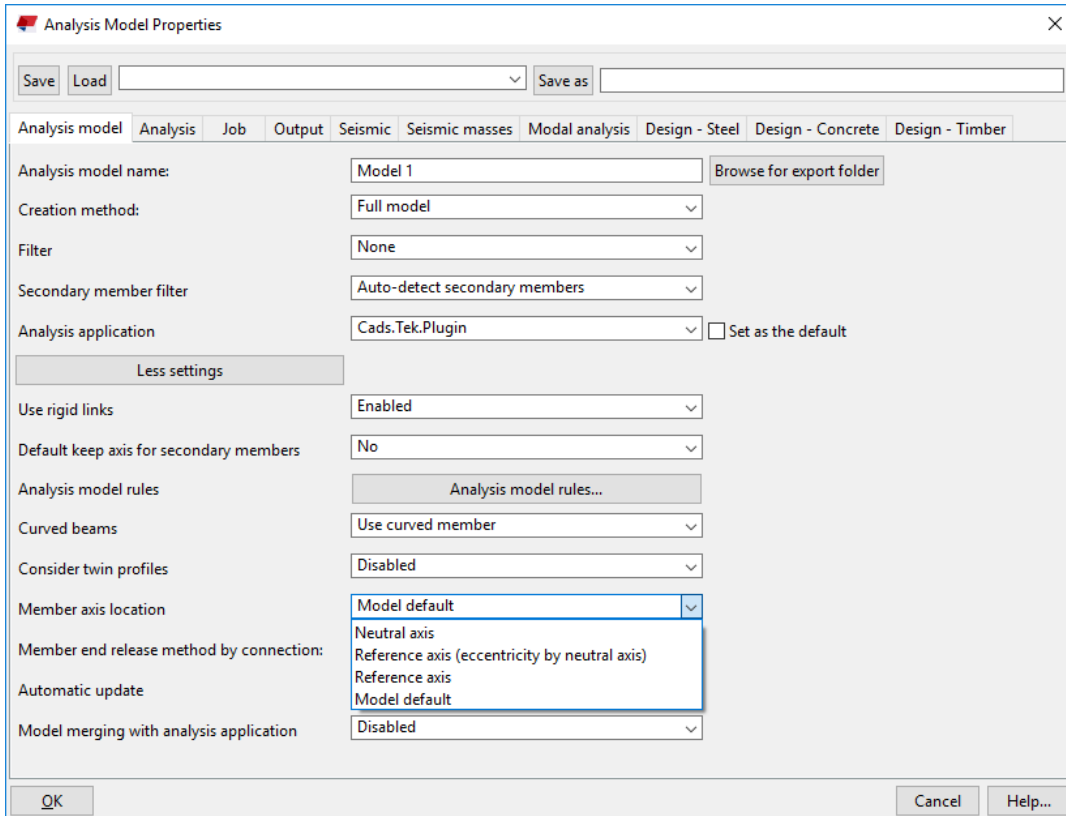

Selecting “Get analysis properties” for a 2D member will display the following dialog.

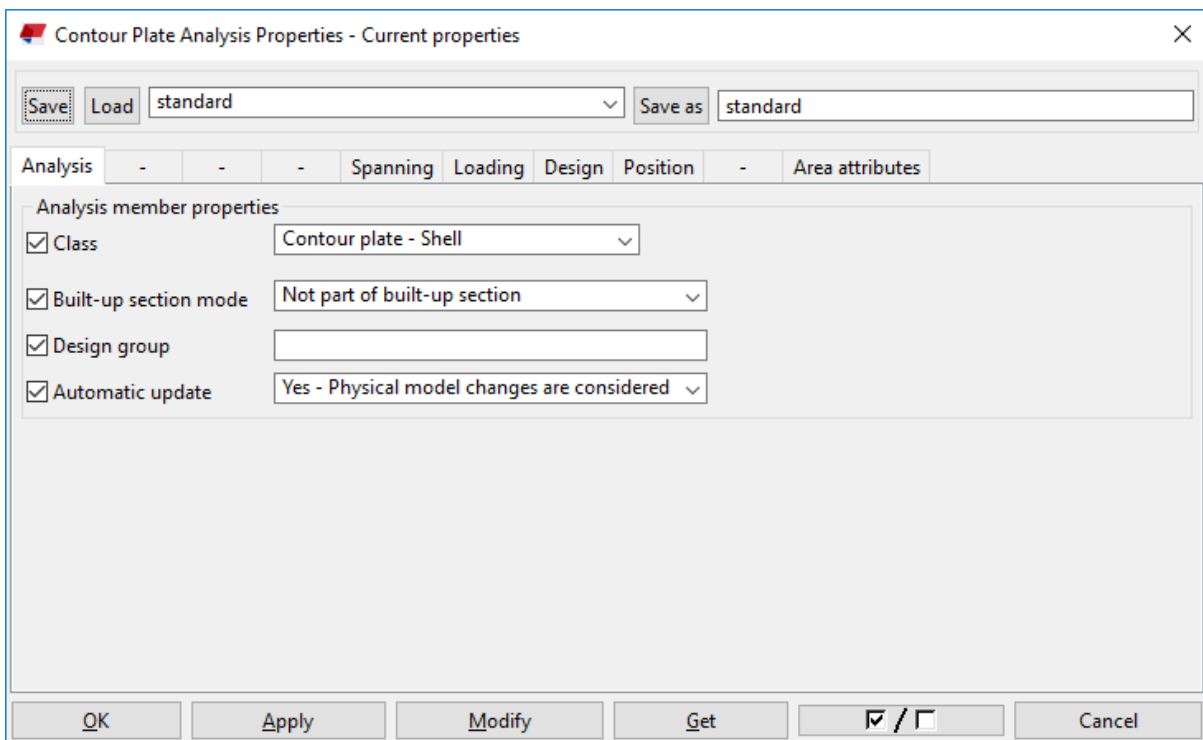

Similar to 1D members, the position tab can be used to change the position of analysis line for 2D members too.

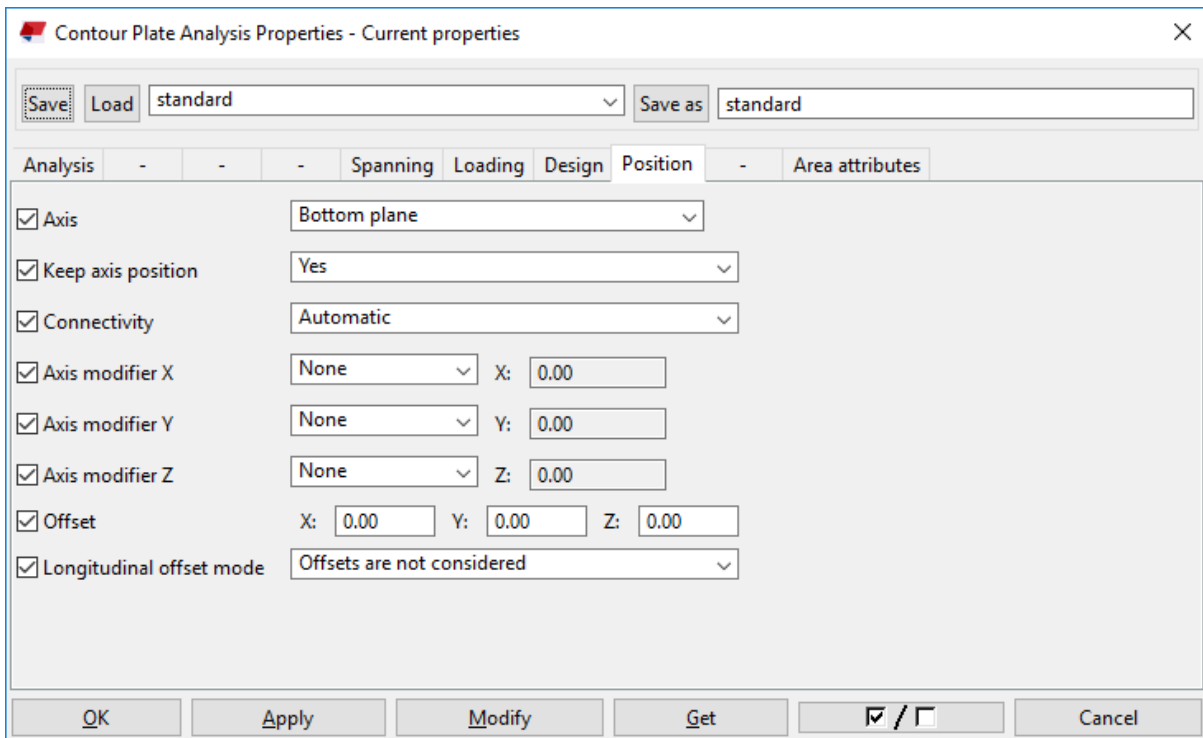

Once the analytical model is created. The model is then ready to be exported into SCIA Engineer.

3 Bi-directional Link – Tekla Structures and SCIA Engineer

CADS Tekla Structures SCIA Engineer link supports a bi-directional transfer between Tekla Structure and SCIA Engineer, however, it can be launched only from Tekla Structures.

CADS Tekla Structures SCIA Engineer link is available under:
Applications & components→**Applications**→**SCIA Engineer**

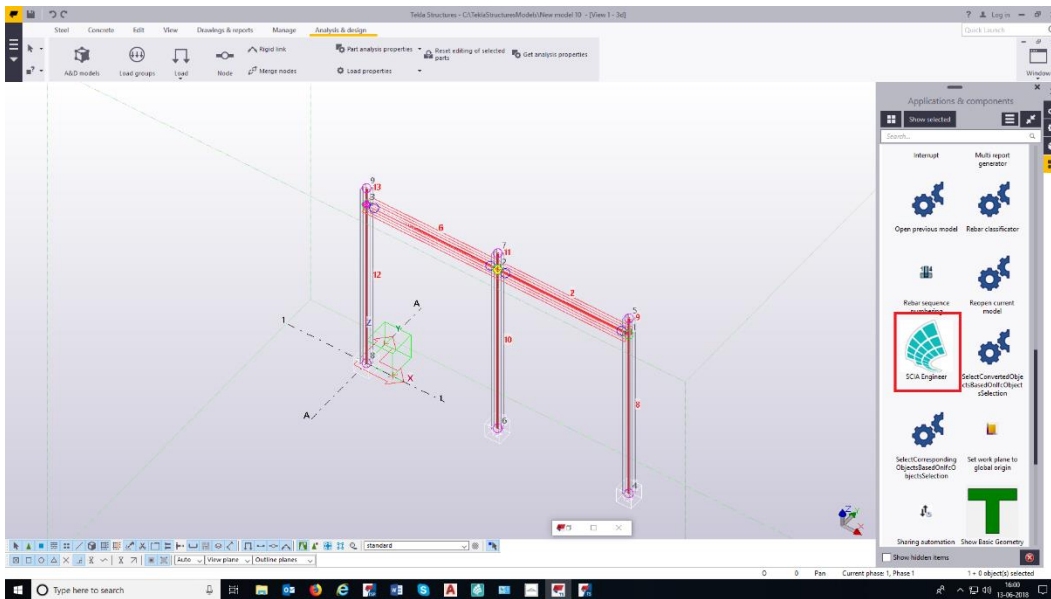

Selecting “SCIA Engineer” will display the following dialog.

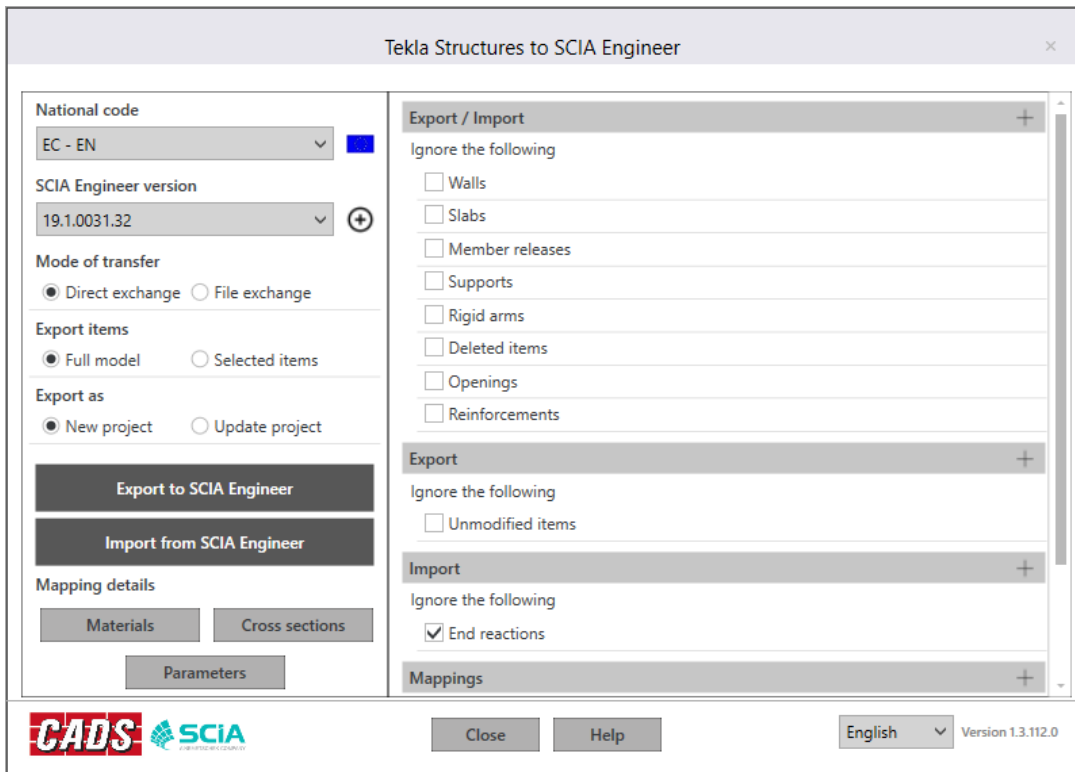

3.1.1 National code

The national code option specifies which National Code is to be used when the model is transferred to SCIA Engineer. The material mapping is dependent on the National Code and hence it is important to select the correct National Code. This option is valid only when the model is exported from Tekla Structures to SCIA Engineer. It is not required when importing from SCIA Engineer back to Tekla Structures.

The following National Codes are supported in this version:



3.1.2 Mode of transfer

Mode of export

Direct exchange File exchange

This option works differently depending on the context in which it is used.

If the model is exported from Tekla Structures, the option “Mode of Export = Direct Exchange” launches SCIA Engineer and exports the model into it.

When importing from SCIA Engineer, the option “Direct Exchange” reads the active SCIA Engineer job and updates the current Tekla Structures model.

The file exchange option works with an intermediate file (*.t2s or *.s2t) which is used for data transfer. If the model is exported from Tekla Structures, the option “Mode of Export = File Exchange” writes the analytical model data as a Tekla - SCIA Engineer file (e.g. model.t2s) which can be opened/imported into SCIA Engineer using the command “Import → Tekla File.”

When importing from SCIA Engineer, the option “File Exchange” asks you to choose the SCIA Engineer-Tekla file (e.g. model.s2t) and when the file is selected it is updated to the current Tekla Structures model.

Note:

The File Exchange option does not require the full version of SCIA Engineer to be installed on the computer. It allows sending the file to others who have the full version of SCIA Engineer installed.

3.1.2.1 Export items

Export items

Full model Selected items

This option allows you to specify what to export from Tekla Structures to SCIA Engineer: all or only selected members of the chosen analytical model. If you have more than one analytical model while exporting you will be asked to choose the model that you wish to export.

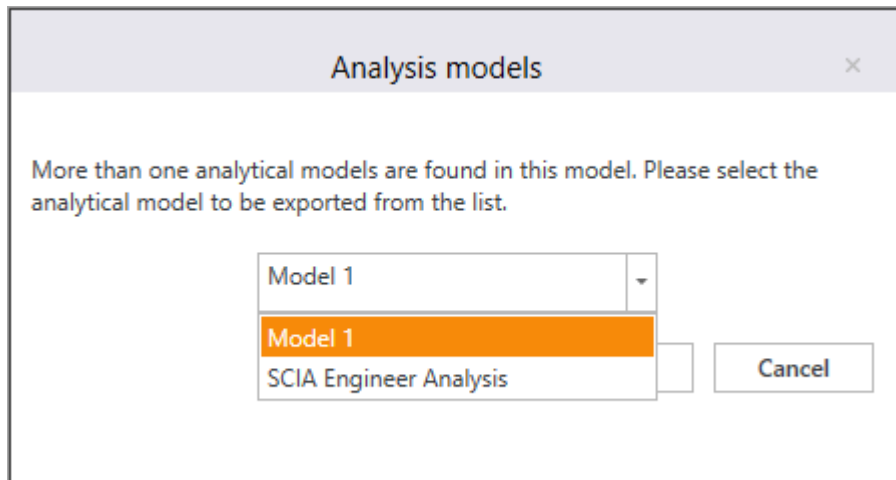

3.1.3 Create/Update



This option allows the export of a model from Tekla Structures as a new project or to update an existing SCIA Engineer model.

If you select “New project”, then the existing SCIA Engineer file with the same name (if it exists) in the folder is deleted and a new SCIA Engineer file is created (if it is not already opened in SCIA Engineer). If the file is already opened in SCIA Engineer, it cannot overwrite the file and a warning message will be displayed.

If you select “New project”, then the “Export to SCIA Engineer” will update any existing SCIA Engineer file with the same name that is available in the folder. Otherwise, a new project is created.

Note: While updating project from Tekla Structures to SCIA Engineer, If any sections were changed from L section to other section shapes or the vice versa the model will not be updated.

3.1.4 Export / Import

Selecting “Export to SCIA Engineer” exports/updates the Tekla Structures model into SCIA Engineer. Selecting the “Import from SCIA Engineer” imports/updates the Tekla Structures model from SCIA Engineer.

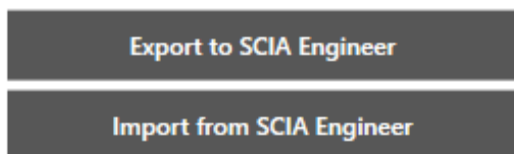

Export and Import of material and cross sections between the applications are primarily based on mapping database as the standard cross section and material libraries in both **Tekla Structures** and **SCIA Engineer** are comprehensive but are labelled differently.

CADS Tekla Structures SCIA Engineer link is shipped with a pre-installed mapping databases for materials. You can review the database that is accessible by clicking the respective buttons under “Mapping Details”

Mappings

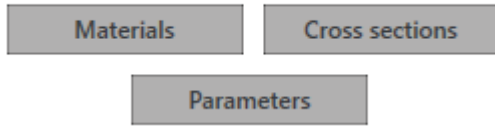

3.1.4.1 Materials

Selecting the “Materials” command displays a dialog where the “Database” list shows the available mapping databases. The General materials database lists the default mapping available in Tekla Structures.

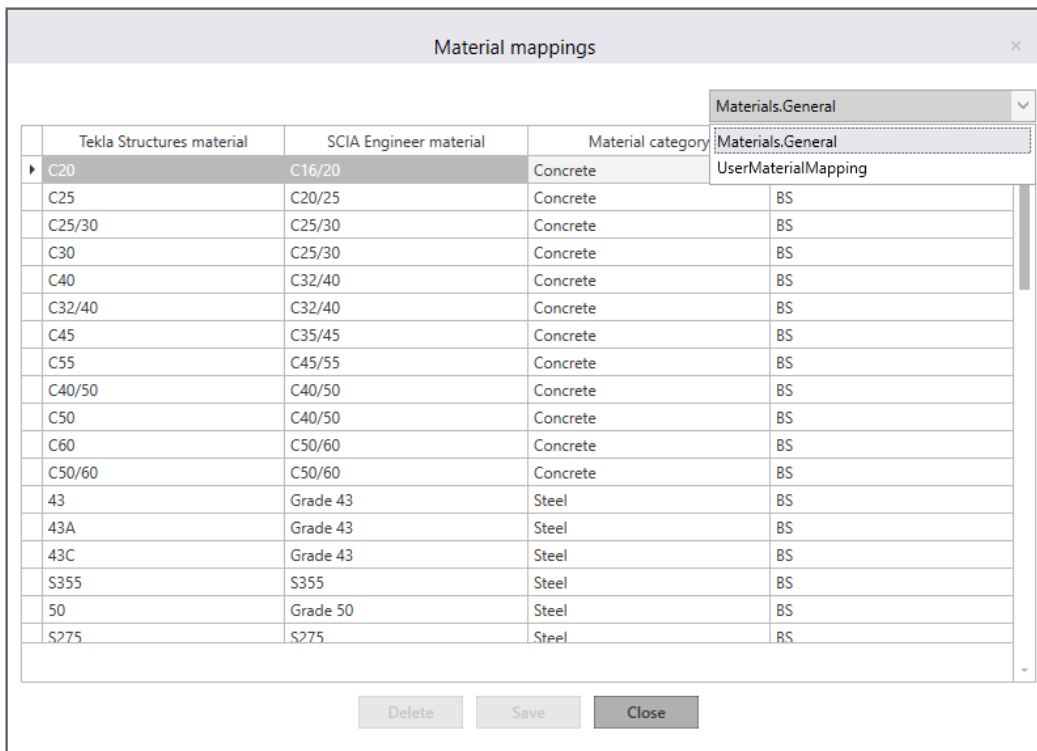

In the same way, the User material-mapping database lists the user-defined mapping available. This mapping will apply to all the jobs in that computer. The user table will be blank before any user mapping is done.

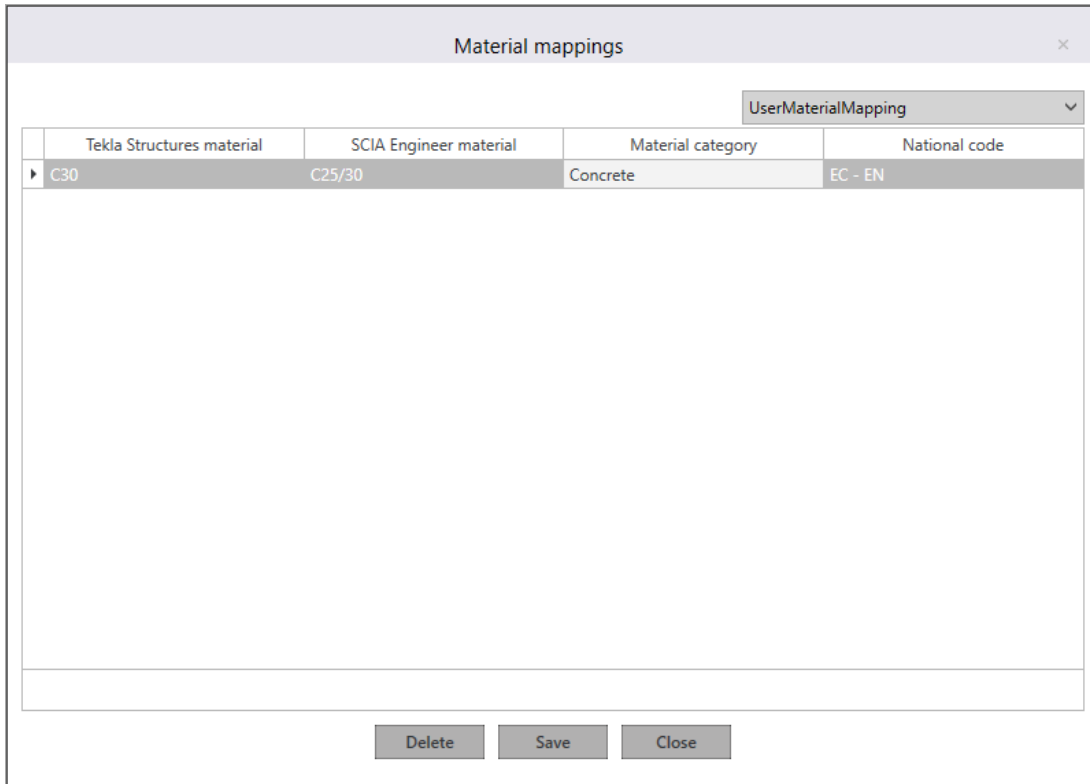

3.1.4.2 Cross-section

For cross sections, only the user-defined section mapping will be displayed. This is computer specific, and it will be the same across all the jobs on the computer.

The user table will be blank before any user mapping is done.

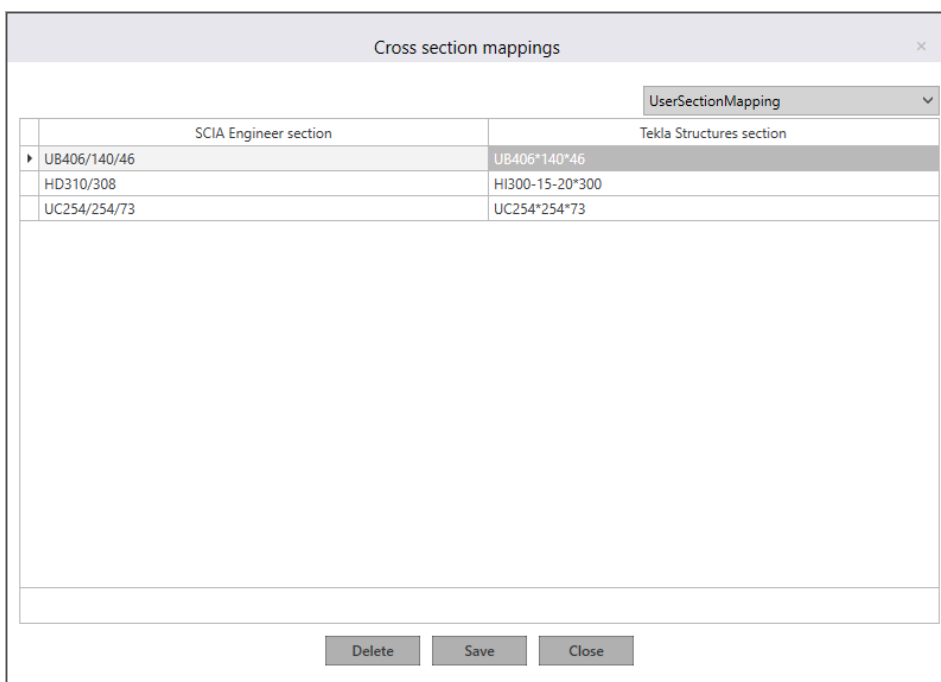

3.1.4.3 Section parameters

In the case of section parameters, all the user-defined parameter mapping will be displayed. This is job specific, and it will be different for any other job. The user table will be blank before any mapping is done.

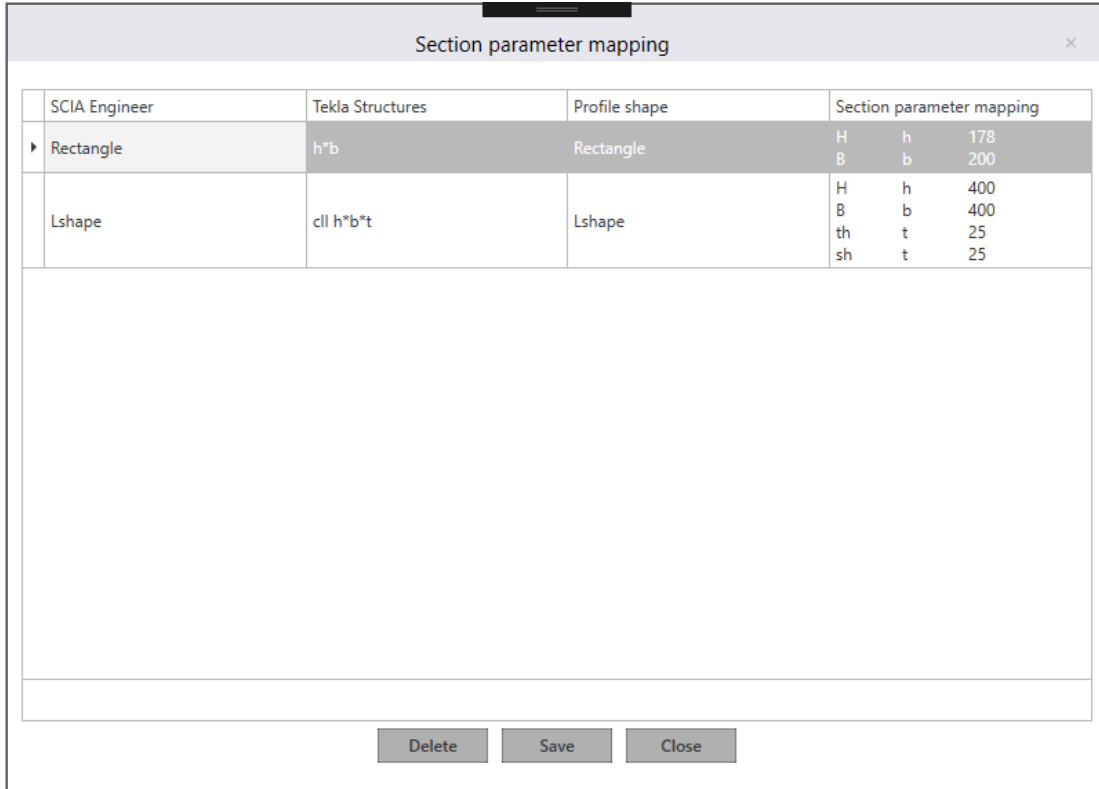

3.1.5 Material mapping

Clicking Export to SCIA Engineer opens the Material mapping dialog

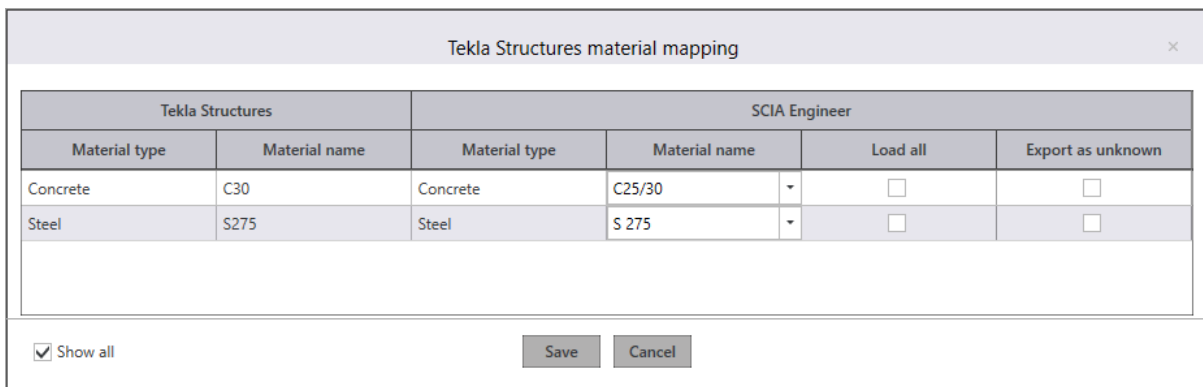

Mapping the Tekla Structures material with SCIA Engineer materials is primarily based on the material type and National Code. If all the parameters are satisfied, the application will automatically map the equivalent SCIA Engineer material. If one or more parameters do not match, the application will prompt you with an exclamation mark to map the equivalent materials through a unified user interface.

Tekla Structures material mapping ×					
Tekla Structures		SCIA Engineer			
Material type	Material name	Material type	Material name	Load all	Export as unknown
Concrete	C30	Concrete	⚠	<input type="checkbox"/>	<input type="checkbox"/>
Steel	S275	Steel	S 275	<input type="checkbox"/>	<input type="checkbox"/>

Show all

To make the mapping easier, the program will offer guidance by suggesting the equivalent materials. The list of suggested materials is made up of those materials that satisfies one or more criteria from which you can pick the desired material.

Tekla Structures material mapping ×					
Tekla Structures		SCIA Engineer			
Material type	Material name	Material type	Material name	Load all	Export as unknown
Concrete	C30	Concrete	⚠	<input type="checkbox"/>	<input type="checkbox"/>
Steel	S235JRG1	Steel	C25/30	<input type="checkbox"/>	<input type="checkbox"/>
Steel	S275	Steel	S 275	<input type="checkbox"/>	<input type="checkbox"/>

Show all

If you are not happy with the suggested list of materials, you have the option to load all materials of the selected National Code and then select the equivalent material to be mapped.

If the material type in Tekla Structures is **Concrete or Steel**, the application will - by default - set the appropriate category and you can then select the correct material from the standard list of materials that are available in SCIA Engineer for the selected National Code.

If the material type in Tekla Structures is **“Unknown”**, the application will allow you to choose any Material type and the material in that category. Alternatively, you can export the material as **“Unknown”**.

Tekla Structures material mapping ×					
Tekla Structures		SCIA Engineer			
Material type	Material name	Material type	Material name	Load all	Export as unknown
Unknown	Elastic putty	⚠	⚠	<input checked="" type="checkbox"/>	<input type="checkbox"/>
Concrete	C30	Concrete	C25/30	<input type="checkbox"/>	<input type="checkbox"/>
Steel	S275	Steel	S 275	<input type="checkbox"/>	<input type="checkbox"/>

Show all

The materials that are mapped by you will be added into the user table, and will be available for subsequent export without your intervention.

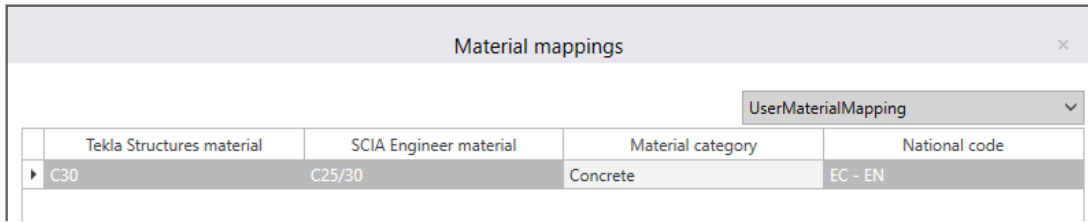

A similar approach is adopted while importing the model from SCIA Engineer to Tekla Structures. You can map the materials from the unified user-interface by selecting the appropriate database and name in Tekla Structures.

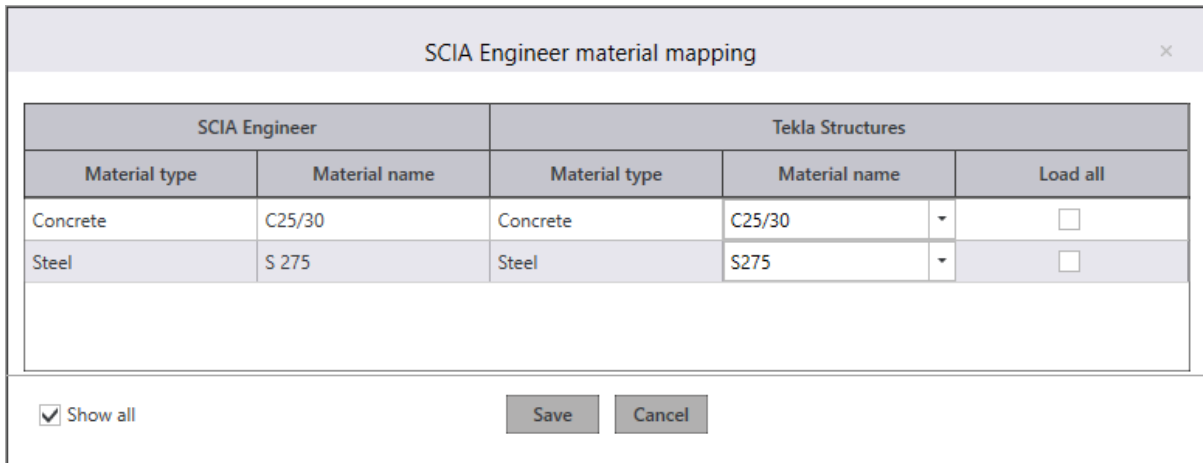

Export as unknown option available in the UI makes the export option easier when a suitable material is not found for the majority of the members, but the export is needed without any prompts for mapping.



If 'Export as Unknown' is checked, the program will not prompt you for mapping a material whenever a material is not found in the mapping database.

If 'Show mapping dialog' is checked, the program will show the mapping dialog during export/import even if all the material/sections is found in the mapping database for us to verify.

3.1.5.1 Section mapping

Once the material mapping is done for standard steel rolled sections, the section mapping between Tekla Structures and SCIA Engineer sections is done using the Mapping tables. For Concrete and general sections, the mapping is done using section parameter mapping.

The standard steel rolled sections will be automatically mapped without your intervention. To make your mapping easier, the program will suggest the equivalent SCIA Engineer section, by reading the Tekla Structures section name. The suggested sections will be shown in the Section list.

Tekla Structures section mapping						
Tekla Structures			SCIA Engineer			
Section name	Material type	Profile shape	Section name	Load all	Export as Numerical	Export as General
UC254*254*73	Steel	I Section	UC254/254/73	<input type="checkbox"/>	<input type="checkbox"/>	<input type="checkbox"/>
UB406*140*46	Steel	I Section	UB406/140/46	<input type="checkbox"/>	<input type="checkbox"/>	<input type="checkbox"/>

Show all

If you are not satisfied with the suggested list, you have an option to load all the databases and their respective section types and sections, by using the “Load all” option and make an appropriate selection.

Tekla Structures section mapping						
Tekla Structures			SCIA Engineer			
Section name	Material type	Profile shape	Section name	Load all	Export as Numerical	Export as General
JUMBO356*406*677	Steel	I Section	⚠	<input checked="" type="checkbox"/>	<input type="checkbox"/>	<input type="checkbox"/>
UB406*140*46	Steel	I Section	HD100/15	<input type="checkbox"/>	<input type="checkbox"/>	<input type="checkbox"/>
UC254*254*73	Steel	I Section	HD100/20	<input type="checkbox"/>	<input type="checkbox"/>	<input type="checkbox"/>
			HD100/24			
			HD130/20			
			HD130/24			
			HD130/28			
			HD130/33			

Show all

Non-standard steel sections, Paired sections, Haunch sections, Light steel sections, Welded sections and the rolled sections are not supported by this version of CADs Tekla Structures SCIA Engineer Link. They have to be mapped manually by selecting the equivalent standard sections from the database. Alternatively, they can be exported as “General Sections” or “Numerical Sections”.

Tekla Structures section mapping						
Tekla Structures			SCIA Engineer			
Section name	Material type	Profile shape	Section name	Load all	Export as Numerical	Export as General
JUMBO356*406*677	Steel	⚠	⚠	<input type="checkbox"/>	<input type="checkbox"/>	<input type="checkbox"/>
UB406*140*46	Steel	I Section	UB406/140/46	<input type="checkbox"/>	<input type="checkbox"/>	<input type="checkbox"/>
UC254*254*73	Steel	I Section	UC254/254/73	<input type="checkbox"/>	<input type="checkbox"/>	<input type="checkbox"/>

Show all

3.1.5.2 Parameter mapping

Concrete sections are mapped by mapping the Tekla Structures parameters with SCIA Engineer dimensional properties. The list of supported shapes of cross sections from Concrete are

- Oval
- Rectangle
- L shape
- Inverted L shape
- T shape

- Circle
- I shape
- U shape
- C shape
- Z shape
- O shape
- X shape
- Polygon

The Parameter mapping dialog will be shown at the time of export and the parameters can be mapped by clicking the **section name** with the exclamation mark.

Tekla Structures section mapping

Tekla Structures		SCIA Engineer				
Section name	Material type	Profile shape	Section name	Load all	Export as Numerical	Export as General
I1900*400*200-100-300*200	Concrete	I shape	⚠ Concrete Ishape	<input checked="" type="checkbox"/>	<input type="checkbox"/>	<input type="checkbox"/>

Show all

Section parameter mapping

SCIA Engineer parameter	Tekla Structures parameter	Parameter value (mm)
H	h	900
Bh	b1	400
Bs	b2	300
ts	t1	200
th	t2	200
s	s	100

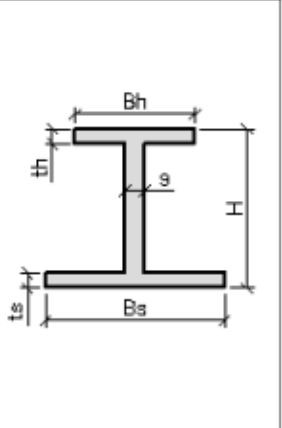

Once the parameters are mapped, the sections will be added into the unified user-interface dialog in the Section mapping. The mapped parameters can be reviewed by clicking the Section name button.

Tekla Structures SCIA Engineer link Help

Tekla Structures			SCIA Engineer			
Section name	Material type	Profile shape	Section name	Load all	Export as Numerical	Export as General
I1900*400*200-100-300*200	Concrete	I shape	Concrete Ishape	<input checked="" type="checkbox"/>	<input type="checkbox"/>	<input type="checkbox"/>

Show all Save Cancel

All the mapped sections will be added into the user table, which will be available for subsequent export without your intervention. Please note that the section parameter mapping is stored along with the individual job and hence it will not be available for other Tekla Structures job.

SCIA Engineer	Tekla Structures	Profile shape	Section parameter mapping		
▶ Rectangle	h*b	Rectangle	H	h	178
			B	b	200
Lshape	c l h*b*t	Lshape	H	h	400
			B	b	400
			th	t	25
			sh	t	25

Delete Save Close

The approach is very similar while importing/updating the model from SCIA Engineer to Tekla Structures. You can map the sections from SCIA Engineer in the unified user-interface by selecting the appropriate database in Tekla Structure.

3.1.5.3 Export/Import options

These options allow you to ignore certain items so they are not exported from Tekla Structures, or imported from SCIA Engineer.

Export / Import	+
Ignore the following	
<input type="checkbox"/> Walls	
<input type="checkbox"/> Slabs	
<input checked="" type="checkbox"/> Member releases	
<input type="checkbox"/> Supports	
<input type="checkbox"/> Rigid arms	
<input type="checkbox"/> Deleted items	
<input type="checkbox"/> Openings	
<input type="checkbox"/> Reinforcements	
Export	+
Ignore the following	
<input type="checkbox"/> Unmodified items	
Import	+
Ignore the following	
<input checked="" type="checkbox"/> End reactions	

- If the “Walls” option is checked, structural walls are not considered for both export and import.
- If the “Slabs” option is checked, structural slabs are not considered for both export and import.
- If the “Member Releases” is checked, member end releases slabs are not considered for both export and import.
- If the “Support” option is checked, the support fixities are not considered for both export and import.
- If the “Rigid arms” option is checked, the rigid links are not considered for both export and import.
- If the “Deleted items” is checked, while updating the model if any member information is missing while export/import, those members will not be deleted. This will required when only selected members are exported/imported.
- If the “Openings” option is checked, the openings on 2D members are not considered for both export and import.
- If the “Reinforcements” option is checked, the reinforcements are not considered for both export and import.
- If the “Unmodified items” is checked, while updating the model from Tekla Structures to SCIA Engineer the unmodified items in Tekla Structures are not exported.

- If the “End reactions” is un-checked, while importing the model from SCIA Engineer end reactions for the 1D members will be imported for the selected load case/combination/result class. Once you un-check the “End reactions” option you will need to choose the type of (load case/load combination/result class) and Combination (All ULS,...) for which the end reactions are to be imported.

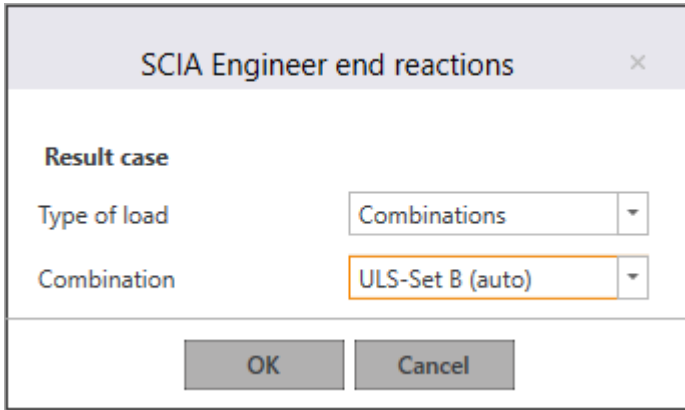

3.1.5.4 Log files

On completion of the export/import routine, the Log dialog shows a summary of the number of items exported. A log file will be saved automatically in the job location in folder ..\SCIA Engineer\Reports. It can be opened in a browser any time to review the transfer.

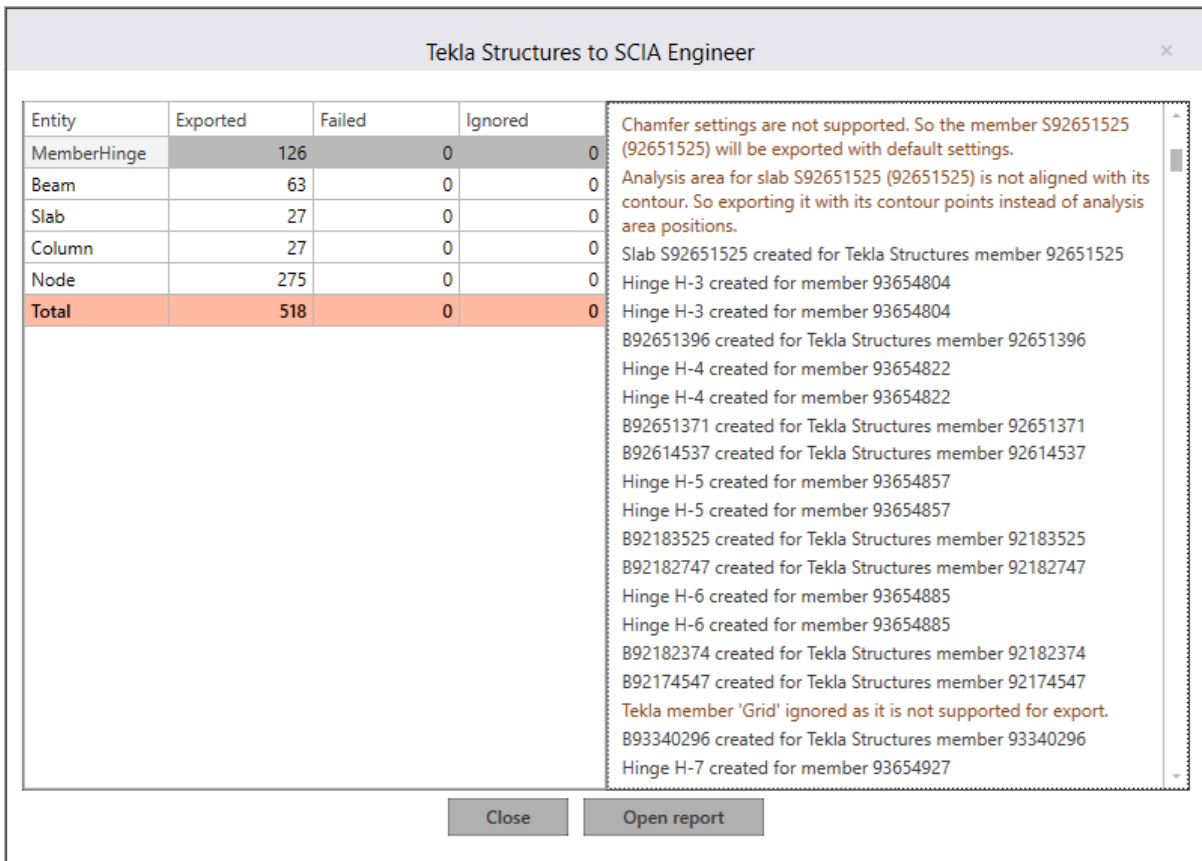

Tekla Structures SCIA Engineer link Help

The *Log* file itemises each element that has been transferred between **Tekla Structures** and **SCIA Engineer**. It details the section / material and its mapping. Any elements that have not been successfully transferred are shown in red. At the end of the transfer of the model from **Tekla Structures** to **SCIA Engineer** and vice versa.

4 Release Notes

Thank you for upgrading to the latest version of CADS Tekla Structures SCIA Engineer link.

These release notes summarise the enhancements and corrections made.

The versions supported for the current release are:

Tekla Structures 2020, 2021	SCIA Engineer 19.0, 19.1, 20.0
-----------------------------	--------------------------------

Version 1.5 (Build 131): May 2021

Enhancements

1. Support for Tekla Structures 2021.

Corrections made

1. While importing geometrical sections into Tekla Structures, some of the sections were not imported. This has been fixed.

Version 1.4 (Build 123): August 2020

Enhancements

1. Export of twin profiles to SCIA Engineer is now supported, with the twin profiles being exported as two separate members to SCIA Engineer;
2. Import of reinforcement from SCIA Engineer is now supported;
3. Export of 1D reinforcement to SCIA Engineer is now supported for rectangular, circular, T and L sections;
4. Support for Tekla Structures 2019i and 2020.

Version 1.3 (Build 92): August 2019

Enhancements

1. Support of openings in 2D members.

Version 1.2 (Build 82): April 2019

Enhancements

2. Support for Tekla Structures 2018i and 2019.

Version 1.1 (Build 68): August 2018

Corrections made



1. End reactions were not exported for concrete members. This has now been fixed;
2. Non-analytical members were removed during update of members from SCIA Engineer to Tekla Structures. This has now been fixed;

Version 1.0 (Build 66): June 2018

Enhancements

1. Support for Tekla Structures 2017i and 2018.

Version 1.0 (Build 62): May 2018

1. First release of Tekla Structures - SCIA Engineer link.

Program features

1. Transfer of 1D and 2D members;
2. Transfer of supports;
3. Transfer of rigid links;
4. Transfer of releases/hinges on 1D members.
5. Transfer of rotation, eccentricity and alignment of 1D members;
6. Transfer of data can be done directly or using file exchange between Tekla Structures and SCIA Engineer.
7. Import of end reactions for a selected load case/combo/result class from SCIA Engineer to Tekla structures.
8. Export/update of only selected members from Tekla Structures to SCIA Engineer;
9. Automatic mapping of cross section and material for standard sections/materials;
10. Cross section can be exported as numerical sections or general sections during export from Tekla Structures to SCIA Engineer.
11. Materials can be exported as unknown material from Tekla Structures to SCIA Engineer.
12. Option to ignore walls, slabs, supports, rigid links and member releases during transfer;
13. Log of all the exported, skipped and failed members will be displayed and saved after data transfer.

Limitations

1. Curved members are not supported in this version;
2. Tapered members are not supported in this version;
3. Openings are not supported in this version;
4. Footings are not supported in this version;
5. Loads and Load combinations are not supported in this version;
6. Analysis results are not supported in this version;
7. If the Reference Line and the Analytical line are different in Tekla Structures, the Reference line details will not be retained when there is a round trip originating in Tekla Structures. Only the Analytical line details will be retained;

8. If the analytical line in Tekla structures is located at the Centre of the cross section, it will be exported to SCIA Engineer to the neutral axis position.

5 Contact Address:

▶ Computer and Design Services Ltd

Arrowsmith Court

10 Station Approach

Broadstone

Dorset BH18 8AX

United Kingdom

Tel. +44 (0)1202 603031

E-mail support@cadscs.co.uk

▶ SCIA nv

Industrieweg 1007

BE-3540 HERK-DE-STAD

Belgium

Tel: 00 32 13 551775

Fax: 00 32 13 554175

E-mail: scia@scia.be

▶ SCIA B.V.

Wassenaarweg 40

6843 NW Arnhem

Netherlands

Tel: 00 31 26 320 1230

Fax: 00 31 26 320 8008

E-mail: scia@scia.nl

▶ SCIA CZ, s.r.o.

Evropská 2591/33d

Praha 6

Czech Republic

CZ-160 00

Tel: 00 42 226 205 600

Fax: 00 42 226 201 673